

Operating instructions

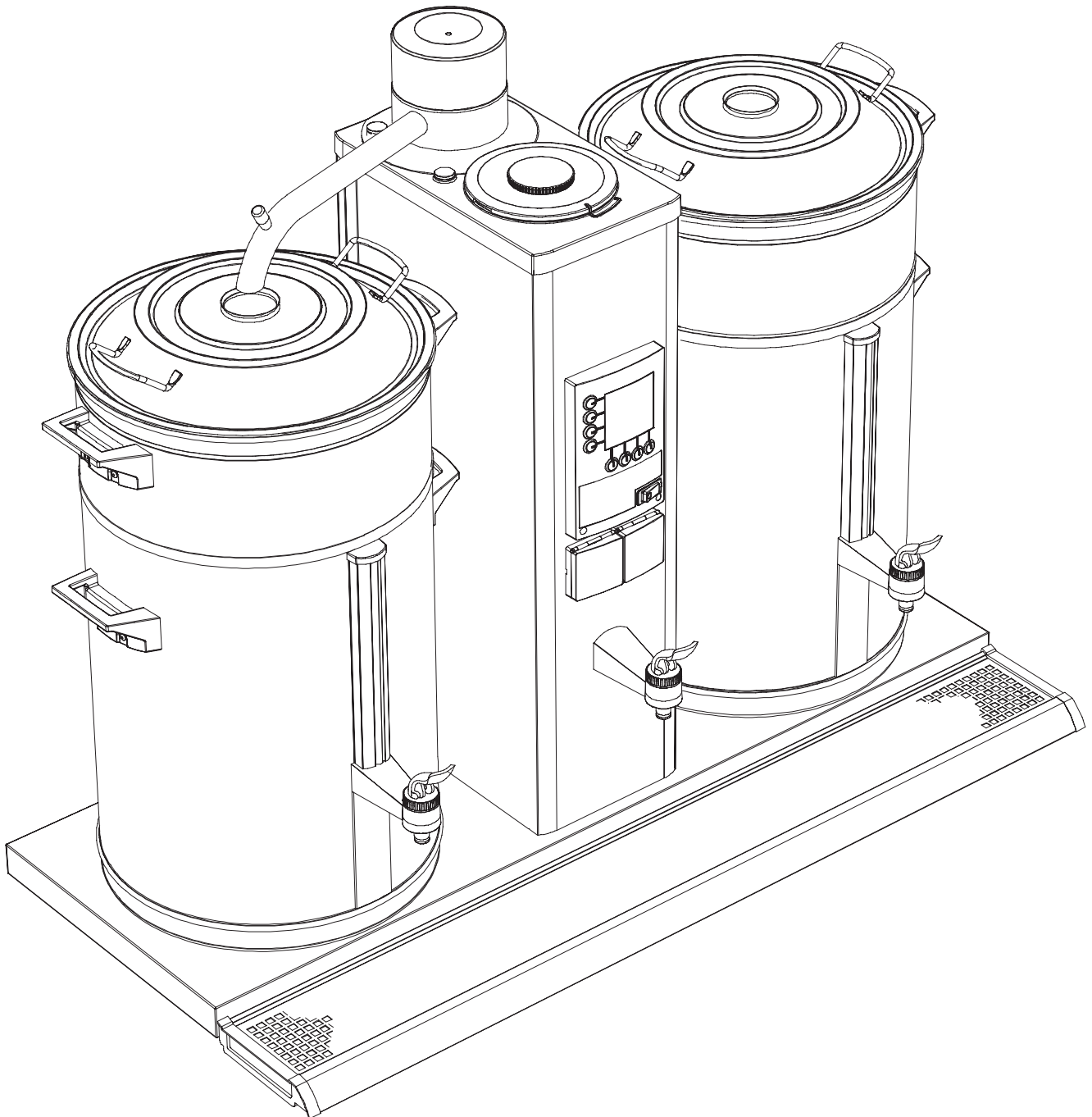



























Photos

ROUND FILTER COFFEE BREWER
WITH HOT WATER TAP



B HW-series

700.403.801

	English	Türkçe	Español	日本語	한글	中文
1.	 Use	Kullanım	Uso	使用	사용	使用
	 Dripping	Damlama	Goteo	滴	추출	滴水
2.	 Cleaning, frequently	Temizleme, sık sık	Limpieza frecuente	頻繁な洗浄	잦은 청소	清潔，次數
	 Wait	Bekleme	Espera	お待ちください	대기	等候
	 Acoustic signal	Sesli sinyal	Señal acústico	音信号	신호음	聽覺信號
3.	 Descaling	Kireçten Arındırma	Descalificar	スケール除去	스케일 제거	清除水垢
	 Read Operating Instructions	Kullanma Talimatini Oku	Lea instrucciones de uso	取扱説明書参照	취급설명서 참조	閱讀操作說明
4.	 Descaling hot water system	Kireçten Arındırma	Descalificar la sección de agua caliente	湯システムのスケール除去	더운물 디스케일링	熱水系統清除水垢
	 Very hot	Çok sıcak	Muy caliente	非常に熱い	매우 뜨거움	很熱
5.	 Initial use	İlk kullanım	Uso inicial	使い初め	사용 초기	初次使用
6.	 Programming (operator)	Programlama (operatör)	Programación (operador)	(ユーザー)プログラミング	사용자 프로그래밍	程式(操作)
	 Selection keys	Seçme düğmeleri	Tecla de selección	選択ボタン	선택 키	選擇按鍵
	 Confirm	Onayla	Confirmar	確定	확정	確定
	 Cancel	İptal	Cancelar	キャンセル	취소	取消
	 Water hardness	Suyun sertliği	Dureza de agua	水硬度	수질 경도	水的硬度
	 Read Operating Instructions	Kullanma Talimatini Oku	Lea instrucciones de uso	取扱説明書参照	취급설명서 참조	閱讀操作說明
7.	 Programming (principal)	Programlama (esas)	Programación (principal)	(主要な)プログラミング	프로그래밍(원리)	程式(主要的)
	 Selection keys	Seçme düğmeleri	Tecla de selección	選択ボタン	선택 키	選擇按鍵
	 Confirm	Onayla	Confirmar	確定	확정	確定
	 Cancel	İptal	Cancelar	キャンセル	취소	取消
	 Off	Kapalı	Apagado	オフ	오프	關閉
	 Min.	En Az	Min.	最小	최소	最小
	 Standard	Standart	Estándar	標準	표준	標準
	 Max.	En Fazla	Max.	最大	최대	最大
	 Water hardness	Suyun sertliği	Dureza de agua	水硬度	수질 경도	水的硬度
	 Read Operating Instructions	Kullanma Talimatini Oku	Lea instrucciones de uso	取扱説明書参照	취급설명서 참조	閱讀操作說明
	 Hold 10 sec.	10 san. Tut	Aguante 10 Segundos	10秒待機	10초간 대기	按著10秒
	 Select desired time setting (1-14)	Istenilen zaman ayarini sec (1-14)	Selecciona tiempo deseado (1-14)	時間設定(1-14)の選択	시간설정(1-14)의 선택	選擇所需時間設定(1-14)
8.	 Error codes	Arıza Kod	Códigos de mal función	エラーコード	에러 코드	錯誤的編號

1. USE (B HW)

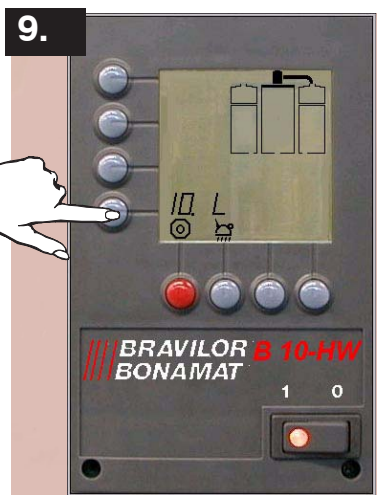
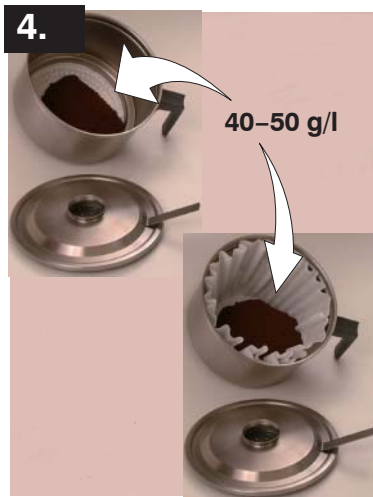
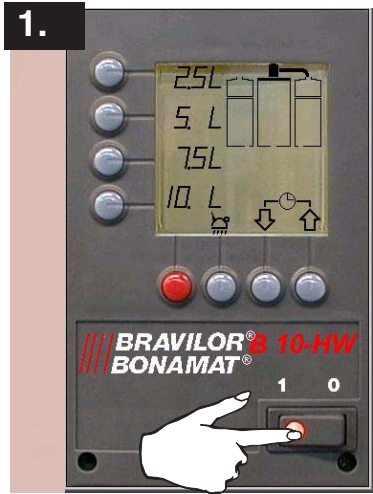

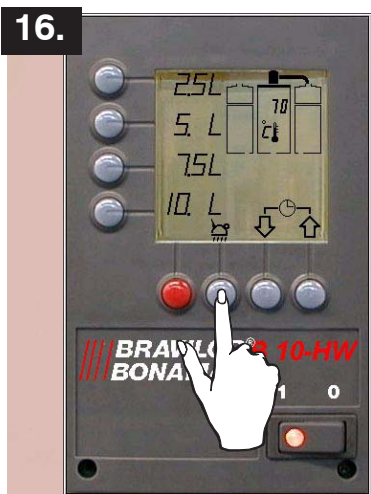

2. CLEANING, FREQUENTLY (B HW)

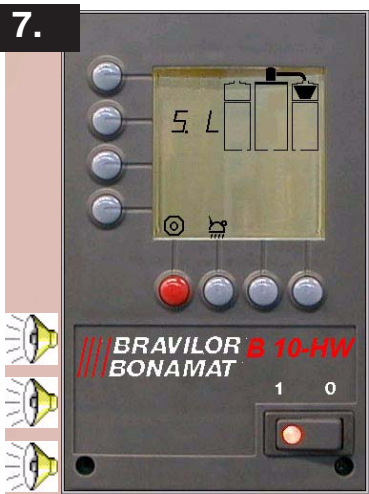
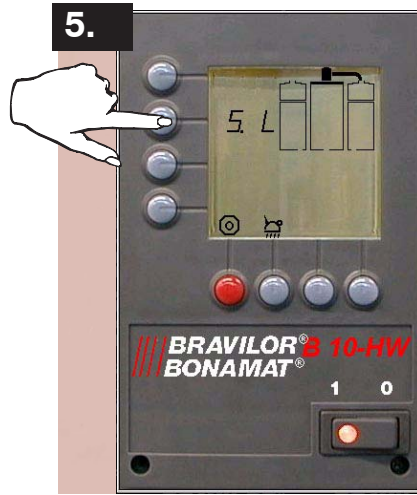
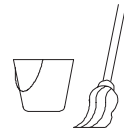

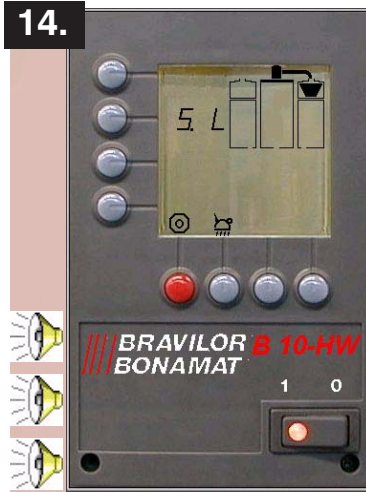





3. DESCALING COFFEE SYSTEM (B HW)

± 30 MIN.

(OPERATOR)

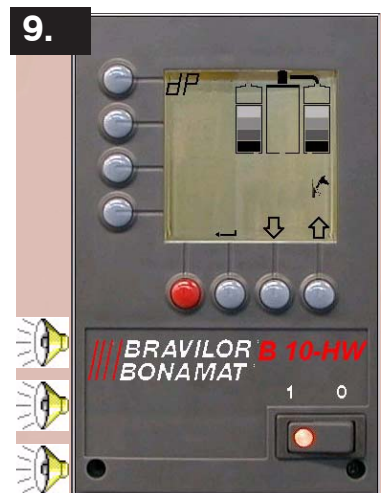
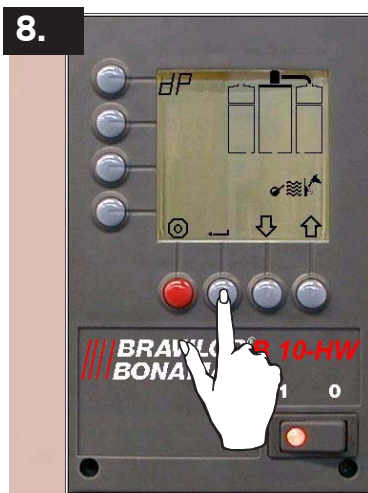
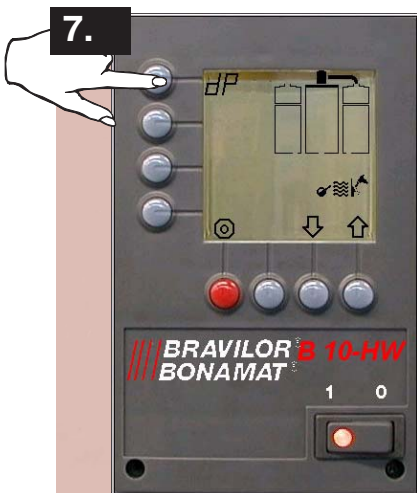
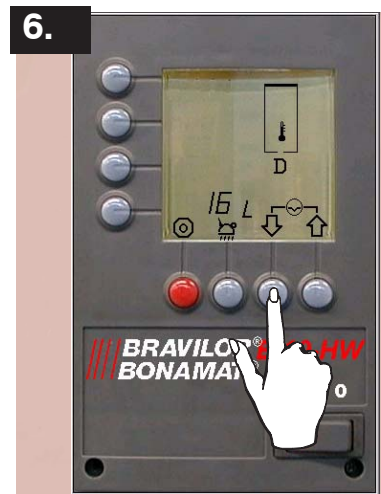
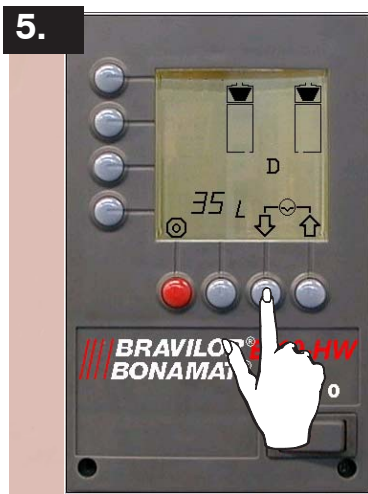
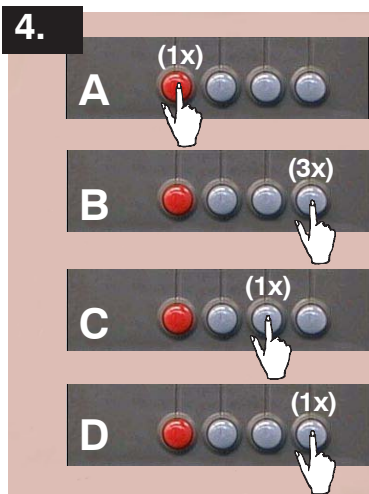

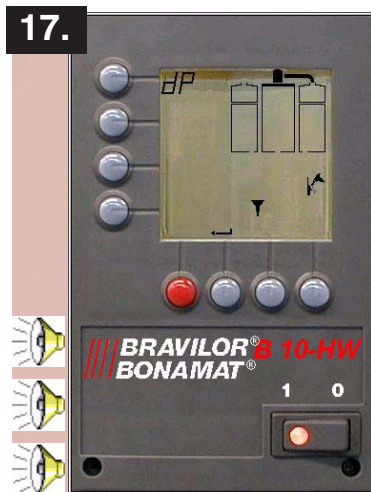
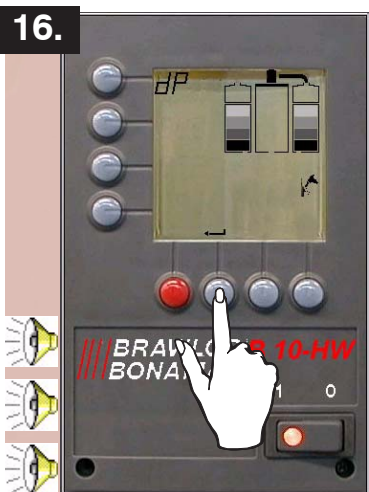
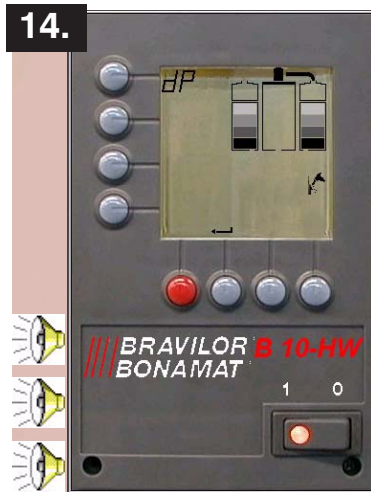
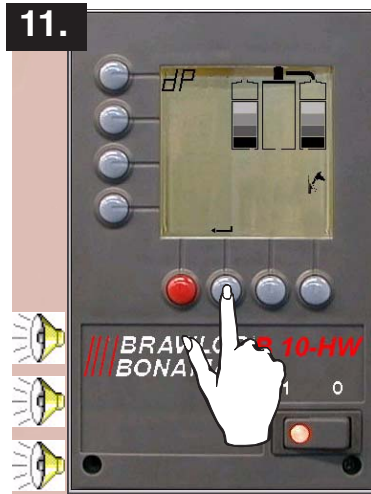

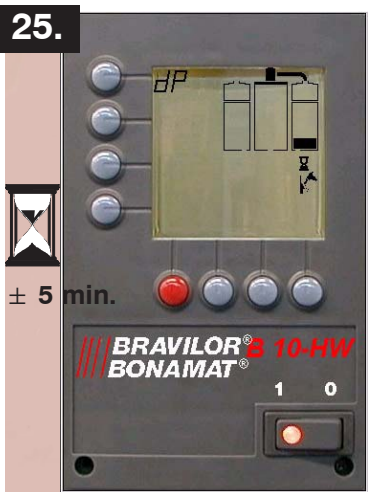
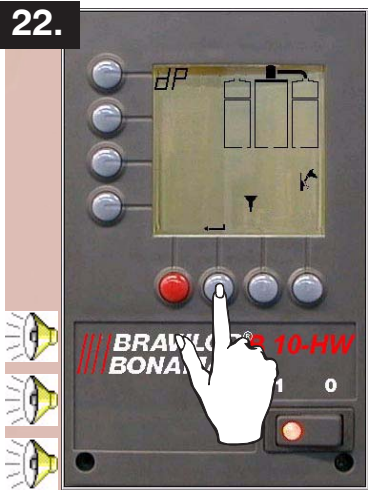

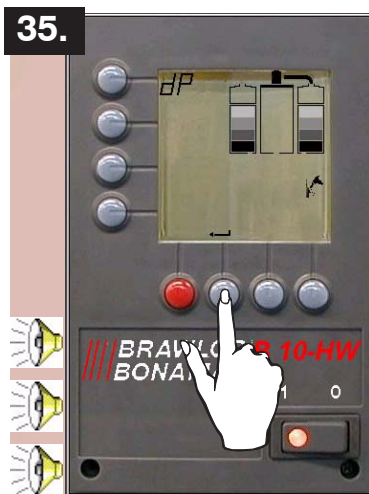
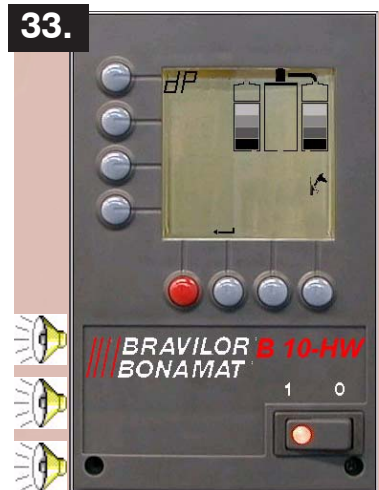
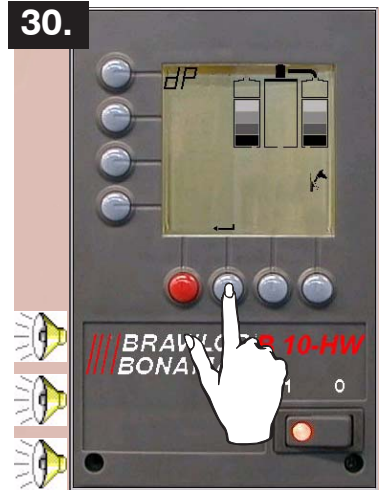
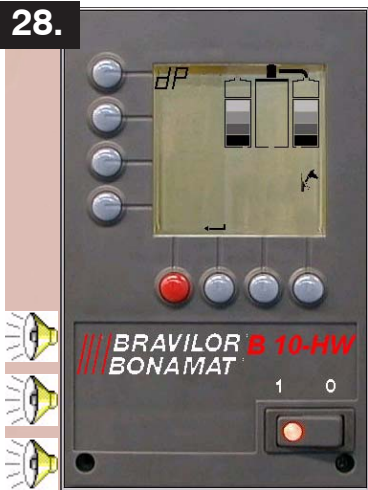

37.



38.

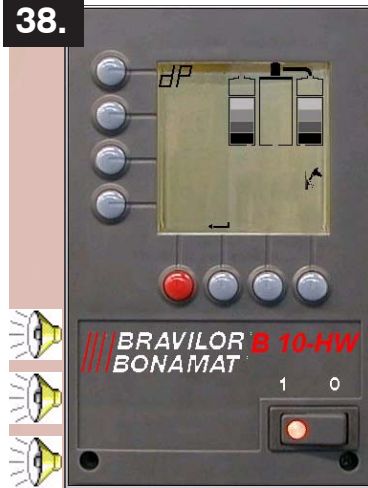

39.



40.

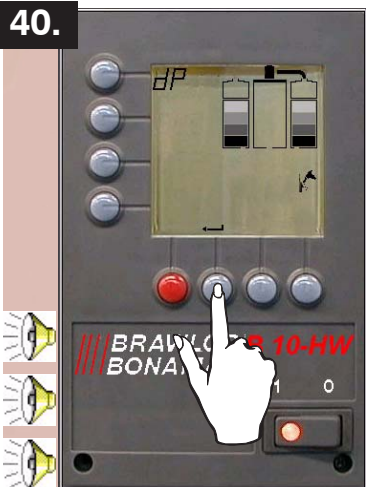

41.



42.



43.

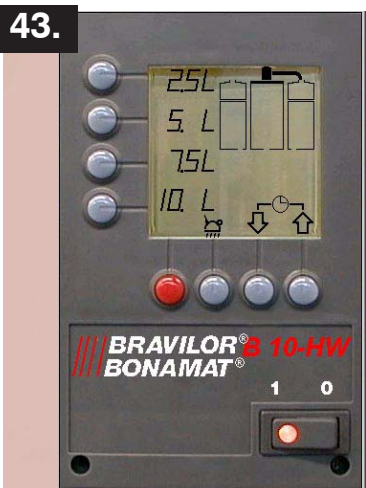

4. DESCALING HOT WATER SYSTEM (B HW)

± 30 MIN.

(OPERATOR)

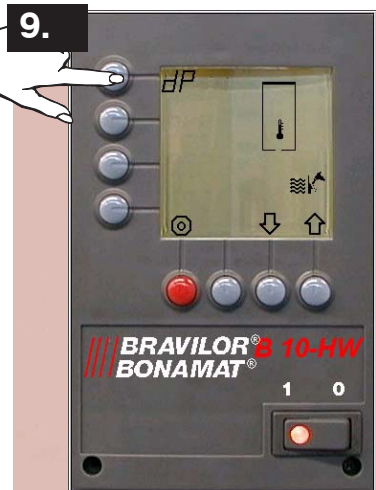
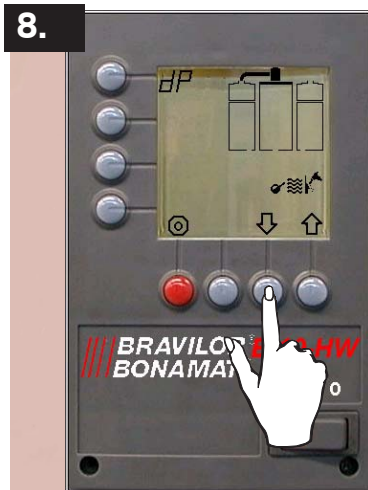
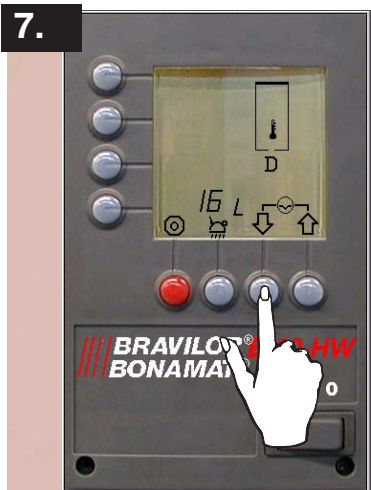
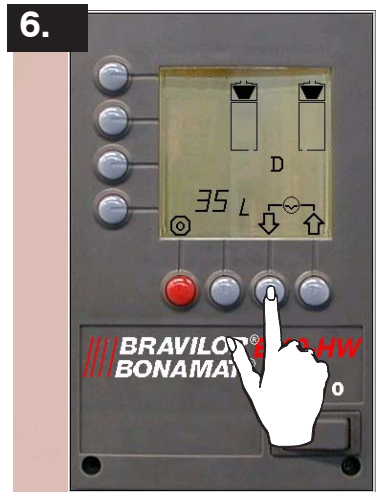
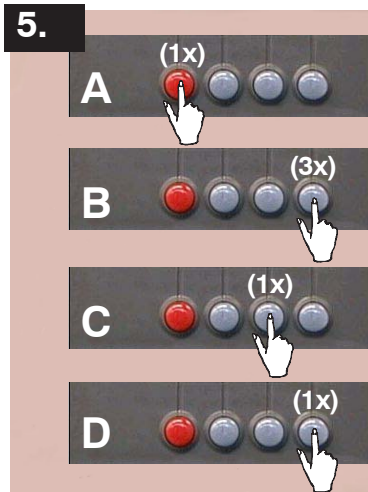

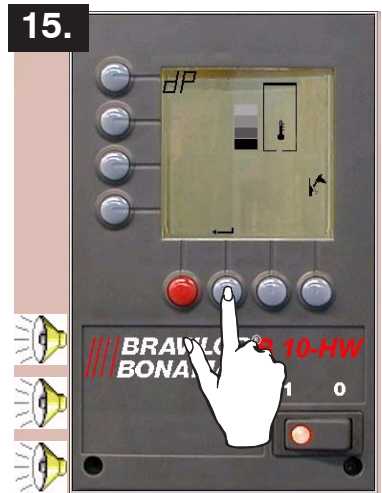
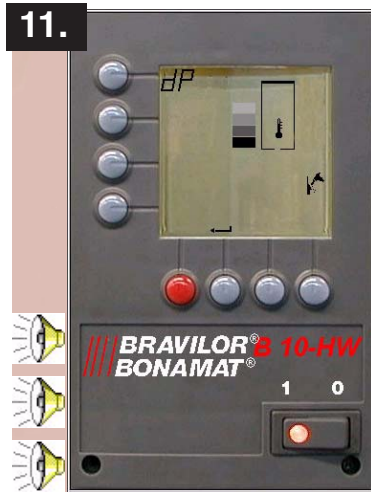
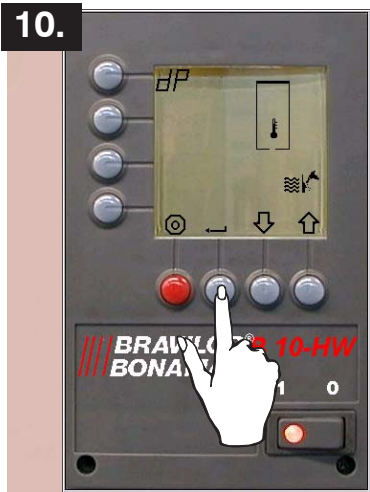

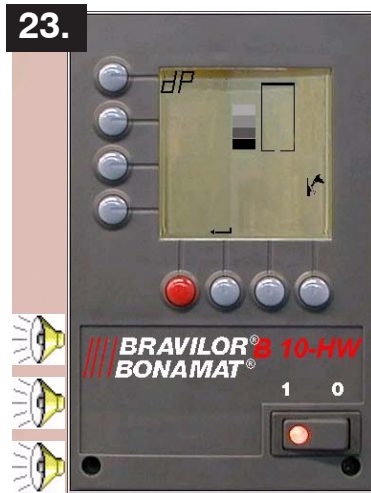
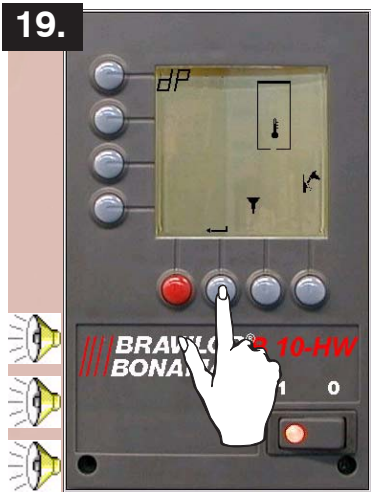

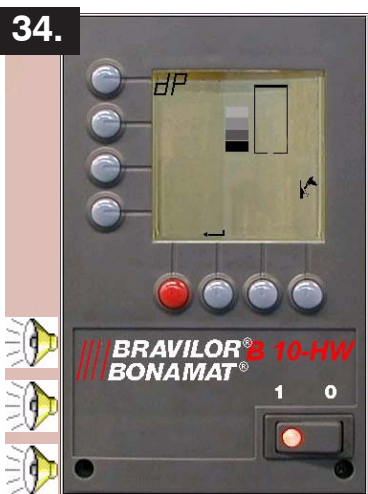
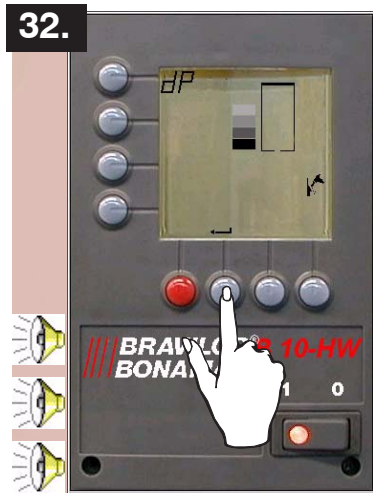

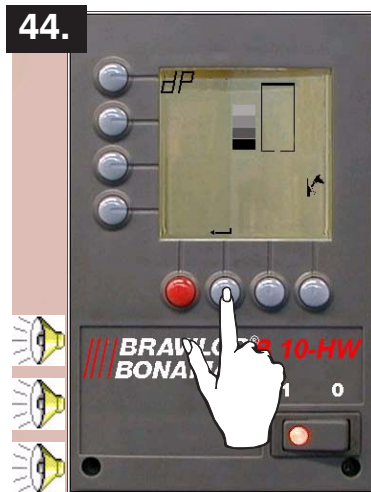
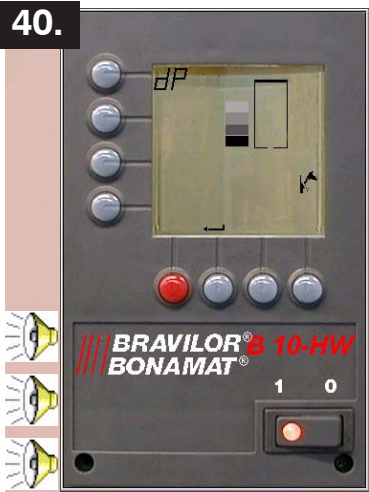
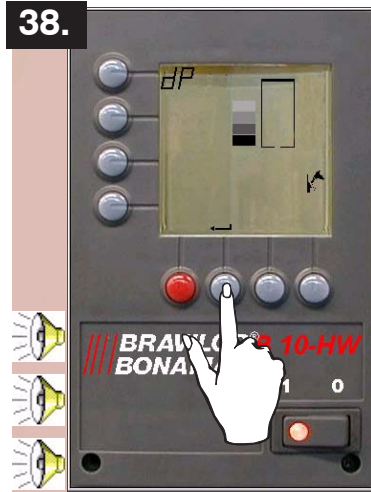

46.



47.

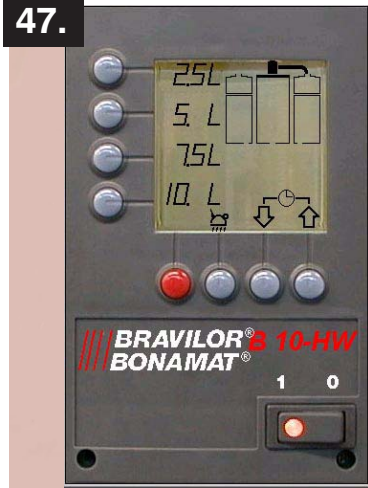



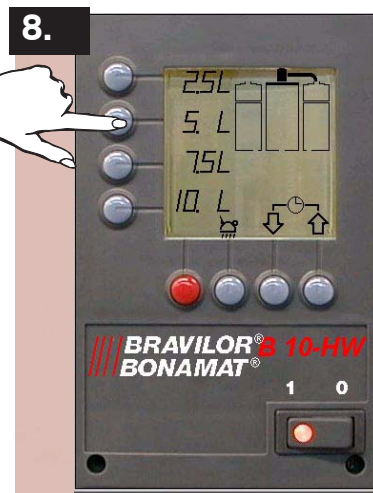
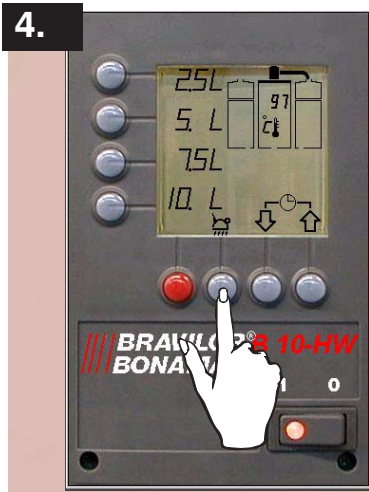
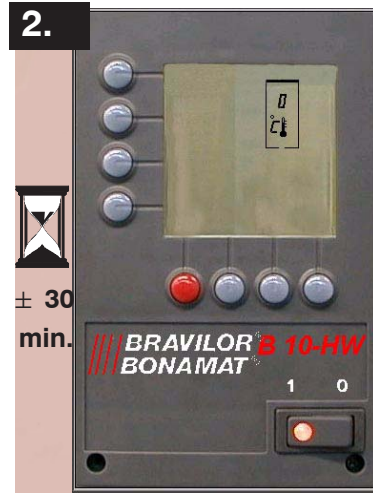
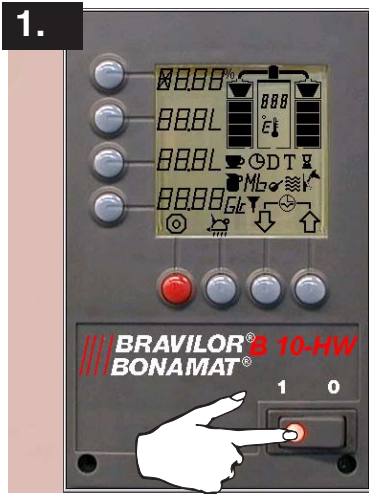

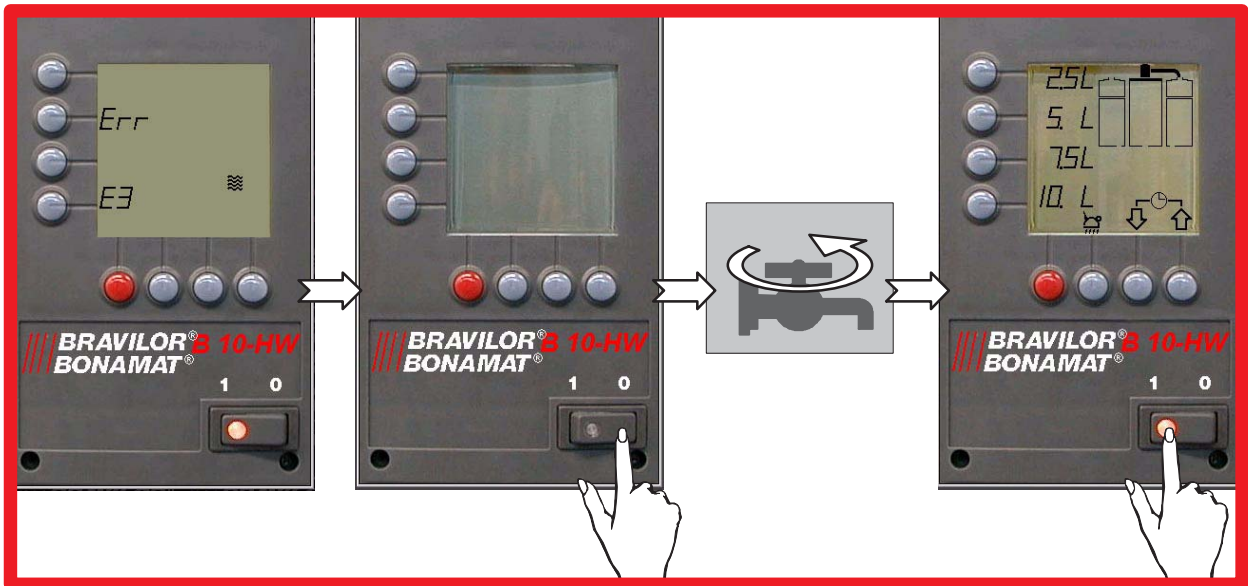



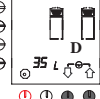

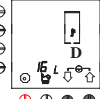

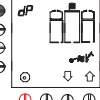



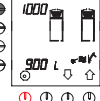



5. INITIAL USE (B HW)



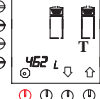

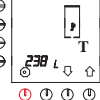
6. PROGRAMMING (B HW) (OPERATOR)

 < 5 sec.				= 0	
				= 0	
			§ 3.		
			§ 4.		
					  
					
					
					
					

7. PROGRAMMING (B HW) (PRINCIPAL USER)

				<table style="width: 100%; border-collapse: collapse;"> <tr> <td style="width: 10%;"></td> <td style="width: 10%; text-align: center;">□</td> <td style="width: 10%;"></td> <td style="width: 10%; text-align: center;">▲</td> <td style="width: 10%;"></td> <td style="width: 10%; text-align: center;">■</td> </tr> <tr> <td>B5 HW</td> <td>4.8</td> <td></td> <td>5.3</td> <td></td> <td>5.8</td> </tr> <tr> <td>B10 HW</td> <td>10.6</td> <td></td> <td>9.6</td> <td></td> <td>11.6</td> </tr> <tr> <td>B20 HW</td> <td>19.2</td> <td></td> <td>21.2</td> <td></td> <td>23.2</td> </tr> </table>		□		▲		■	B5 HW	4.8		5.3		5.8	B10 HW	10.6		9.6		11.6	B20 HW	19.2		21.2		23.2																																																																																																
	□		▲		■																																																																																																																							
B5 HW	4.8		5.3		5.8																																																																																																																							
B10 HW	10.6		9.6		11.6																																																																																																																							
B20 HW	19.2		21.2		23.2																																																																																																																							
				<table style="width: 100%; border-collapse: collapse;"> <tr> <td style="width: 10%;"></td> <td style="width: 10%; text-align: center;">□</td> <td style="width: 10%;"></td> <td style="width: 10%; text-align: center;">▲</td> <td style="width: 10%;"></td> <td style="width: 10%; text-align: center;">■</td> </tr> <tr> <td>B5 HW</td> <td>1</td> <td>1</td> <td>3-4</td> <td>5</td> <td>5</td> </tr> <tr> <td>B10 HW</td> <td>2</td> <td>2.5-5</td> <td>7.5-10</td> <td>10</td> <td>10</td> </tr> <tr> <td>B20 HW</td> <td>4</td> <td>5</td> <td>-10-15</td> <td>-20</td> <td>20</td> </tr> </table> <table style="width: 100%; border-collapse: collapse;"> <tr> <td style="width: 10%;"></td> <td style="width: 10%; text-align: center;">□</td> <td style="width: 10%;"></td> <td style="width: 10%; text-align: center;">▲</td> <td style="width: 10%;"></td> <td style="width: 10%; text-align: center;">■</td> </tr> <tr> <td></td> <td>50</td> <td></td> <td>125</td> <td></td> <td>200</td> </tr> </table> <table style="width: 100%; border-collapse: collapse;"> <tr> <td style="width: 10%;"></td> <td style="width: 10%; text-align: center;">□</td> <td style="width: 10%;"></td> <td style="width: 10%; text-align: center;">▲</td> <td style="width: 10%;"></td> <td style="width: 10%; text-align: center;">■</td> </tr> <tr> <td>B5 HW</td> <td>8</td> <td>8-24</td> <td>32-40</td> <td>40</td> <td>40</td> </tr> <tr> <td>B10 HW</td> <td>20</td> <td>20-40</td> <td>60-80</td> <td>80</td> <td>80</td> </tr> <tr> <td>B20 HW</td> <td>40</td> <td>40-80</td> <td>120-160</td> <td>160</td> <td>160</td> </tr> </table> <table style="width: 100%; border-collapse: collapse;"> <tr> <td style="width: 10%;"></td> <td style="width: 10%; text-align: center;">□</td> <td style="width: 10%;"></td> <td style="width: 10%; text-align: center;">▲</td> <td style="width: 10%;"></td> <td style="width: 10%; text-align: center;">■</td> </tr> <tr> <td></td> <td>50</td> <td></td> <td>250</td> <td></td> <td>3000</td> </tr> </table> <table style="width: 100%; border-collapse: collapse;"> <tr> <td style="width: 10%;"></td> <td style="width: 10%; text-align: center;">□</td> <td style="width: 10%;"></td> <td style="width: 10%; text-align: center;">▲</td> <td style="width: 10%;"></td> <td style="width: 10%; text-align: center;">■</td> </tr> <tr> <td>B5 HW</td> <td>4</td> <td>4-12-16</td> <td>20</td> <td>20</td> <td>20</td> </tr> <tr> <td>B10 HW</td> <td>10</td> <td>10-20-30</td> <td>40</td> <td>40</td> <td>40</td> </tr> <tr> <td>B20 HW</td> <td>20</td> <td>20-40-60</td> <td>80</td> <td>80</td> <td>80</td> </tr> </table> <table style="width: 100%; border-collapse: collapse;"> <tr> <td style="width: 10%;"></td> <td style="width: 10%; text-align: center;">□</td> <td style="width: 10%;"></td> <td style="width: 10%; text-align: center;">▲</td> <td style="width: 10%;"></td> <td style="width: 10%; text-align: center;">■</td> </tr> <tr> <td>B5 HW</td> <td>0.30</td> <td>0.30-0.65-0.95</td> <td>1.30</td> <td>1.30</td> <td>1.30</td> </tr> <tr> <td>B10 HW</td> <td>0.65</td> <td>0.65-1.30-1.95</td> <td>2.60</td> <td>2.60</td> <td>2.60</td> </tr> <tr> <td>B20 HW</td> <td>1.30</td> <td>1.30-2.60-3.95</td> <td>5.25</td> <td>5.25</td> <td>5.25</td> </tr> </table>		□		▲		■	B5 HW	1	1	3-4	5	5	B10 HW	2	2.5-5	7.5-10	10	10	B20 HW	4	5	-10-15	-20	20		□		▲		■		50		125		200		□		▲		■	B5 HW	8	8-24	32-40	40	40	B10 HW	20	20-40	60-80	80	80	B20 HW	40	40-80	120-160	160	160		□		▲		■		50		250		3000		□		▲		■	B5 HW	4	4-12-16	20	20	20	B10 HW	10	10-20-30	40	40	40	B20 HW	20	20-40-60	80	80	80		□		▲		■	B5 HW	0.30	0.30-0.65-0.95	1.30	1.30	1.30	B10 HW	0.65	0.65-1.30-1.95	2.60	2.60	2.60	B20 HW	1.30	1.30-2.60-3.95	5.25	5.25	5.25
	□		▲		■																																																																																																																							
B5 HW	1	1	3-4	5	5																																																																																																																							
B10 HW	2	2.5-5	7.5-10	10	10																																																																																																																							
B20 HW	4	5	-10-15	-20	20																																																																																																																							
	□		▲		■																																																																																																																							
	50		125		200																																																																																																																							
	□		▲		■																																																																																																																							
B5 HW	8	8-24	32-40	40	40																																																																																																																							
B10 HW	20	20-40	60-80	80	80																																																																																																																							
B20 HW	40	40-80	120-160	160	160																																																																																																																							
	□		▲		■																																																																																																																							
	50		250		3000																																																																																																																							
	□		▲		■																																																																																																																							
B5 HW	4	4-12-16	20	20	20																																																																																																																							
B10 HW	10	10-20-30	40	40	40																																																																																																																							
B20 HW	20	20-40-60	80	80	80																																																																																																																							
	□		▲		■																																																																																																																							
B5 HW	0.30	0.30-0.65-0.95	1.30	1.30	1.30																																																																																																																							
B10 HW	0.65	0.65-1.30-1.95	2.60	2.60	2.60																																																																																																																							
B20 HW	1.30	1.30-2.60-3.95	5.25	5.25	5.25																																																																																																																							
				<table style="width: 100%; border-collapse: collapse;"> <tr> <td style="width: 10%;"></td> <td style="width: 10%; text-align: center;">□</td> <td style="width: 10%;"></td> <td style="width: 10%; text-align: center;">▲</td> <td style="width: 10%;"></td> <td style="width: 10%; text-align: center;">■</td> </tr> <tr> <td></td> <td>88</td> <td></td> <td>97</td> <td></td> <td>97</td> </tr> </table> <table style="width: 100%; border-collapse: collapse;"> <tr> <td style="width: 10%;"></td> <td style="width: 10%; text-align: center;">□</td> <td style="width: 10%;"></td> <td style="width: 10%; text-align: center;">▲</td> <td style="width: 10%;"></td> <td style="width: 10%; text-align: center;">■</td> </tr> <tr> <td></td> <td>190</td> <td></td> <td>206</td> <td></td> <td>206</td> </tr> </table>		□		▲		■		88		97		97		□		▲		■		190		206		206																																																																																																
	□		▲		■																																																																																																																							
	88		97		97																																																																																																																							
	□		▲		■																																																																																																																							
	190		206		206																																																																																																																							
				<p style="text-align: center;">▲ EnG</p> <p style="text-align: center;">□ ■ dEu, FrA, ESP, nEd</p> <p style="text-align: center;">▲</p> <p style="text-align: center;">☒ - - - - ■</p> <p style="text-align: center;">off on</p>																																																																																																																								

		↓ / ↑ Select desired time setting (1-14).		← / ⊙	 off on	
	↓ ↑			↓ / ↑	← / ⊙	
	↓ ↑			↓ / ↑	← / ⊙	
	↓ ↑			↓ / ↑	← / ⊙	
	↓ ↑			↓ / ↑	← / ⊙	
	↓ ↑			↓ / ↑	← / ⊙	
	↓ ↑					
	↓ ↑					
	↓ ↑			↓ / ↑	← / ⊙	
	↓ ↑			↓ / ↑	← / ⊙	
	↓ ↑					§ 4. (Operator)
	↓ ↑					§ 3. (Operator)
	↓ ↑			↓ + ↑		= 0
	↓ ↑			↓ + ↑		= 0

8. ERROR CODES (B HW)

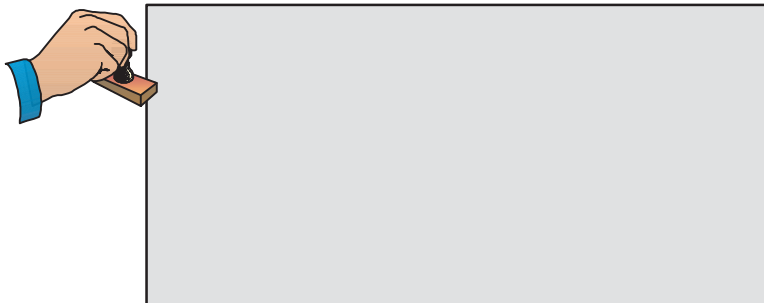
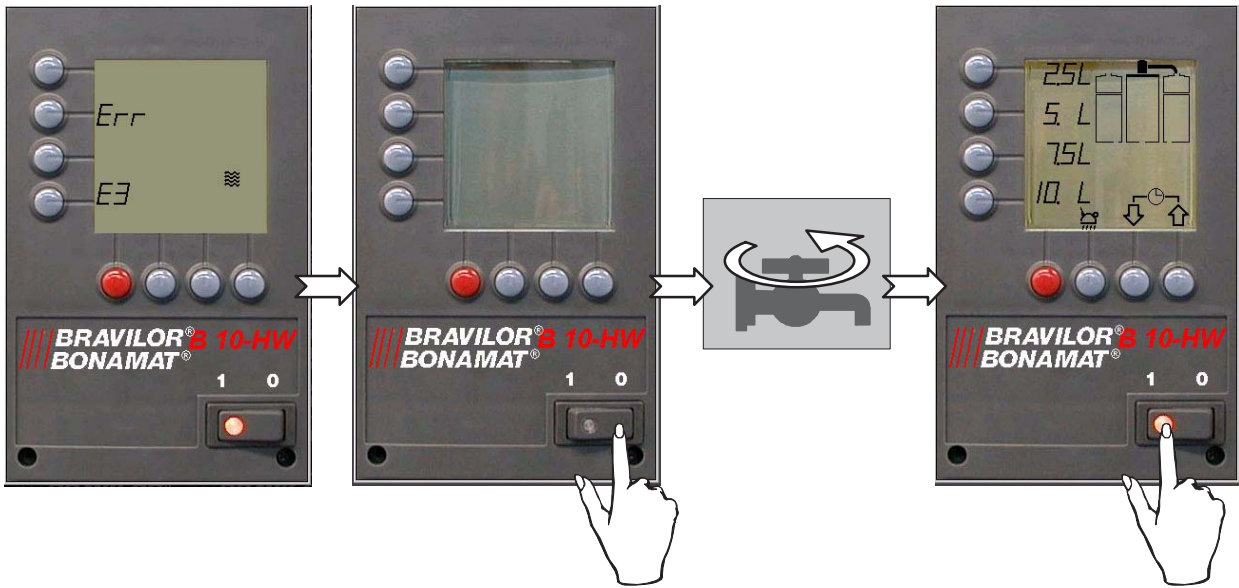



**/// BRAVILOR[®]
BONAMAT**

COFFEE BREWING MACHINES
MACHINES A CAFE
KAFFEEBRUEHMASCHINEN
KOFFIEZETAPPARATEN

© 11-2001

700.403.801