

LAVAVASOS SB-22

GLASSWASHER SB-22

LAVE-VERRES SB-22

N.	Denominación	Description	Dénomination	Cod.
1	Conjunto acoplador inferior	Bottom coupling set	Ensemble accouplement inférieur	2309727
2	Conjunto acoplador superior	Top coupling set	Ensemble accouplement supérieur	2309729
3	Conjunto codo forma U	U shaped elbow set	Ensemble tuyau forme U	2309740
4a	Conjunto difusores inferior	Bottom dispersers set	Ensemble diffuseurs inférieur	2305458
4b	Conjunto difusores superior	Top dispersers set	Ensemble diffuseurs supérieur	2307205
5	Tornillo hélice inox. M-8	Propeller screw M-8	Vis hélice M-8	2305089
6	Conjunto difusores+tapones lavado	Washing dispersers+plugs set	Ensemble diffuseurs+bouchons lavage	2309218
7	Conjunto difusores+tapones aclarado	Rinsing dispersers+plugs set	Ensemble diffuseurs+bouchons rinçage	2309080
8	Conjunto cuerpo difusores inferior	Bottom dispersers body set	Ensemble corps diffuseurs inférieur	2305053
9	Conjunto cuerpo difusores superior	Top dispersers body set	Ensemble corps diffuseurs supérieur	4031665
10	Conjunto programador	Timer set	Ensemble programmeur	2309737
11	Relé con base MY2 220 V.	Relay MY2 220 V.	Relais MY2 220 V.	2050698
12	Contactador B9-4000 220 V. Hz-50	Contactador B9-4000 220 V. Hz-50	Contacteur B9-4000 220 V. Hz-50	2600123
13	Interruptor general-desagüe	Main-drain switch	Interrupteur général-vidange	2310114
14	Maneta roja	Red knob	Commande rouge	2304989
15	Conjunto pilotos	Lamps set	Ensemble lampes	2310131
16a	Conmutador unipolar IR2-10	Commutator IR2-10	Commutateur IR2-10	2306527
16b	Pulsador luminoso ámbar	Amber-light pushbutton	Bouton lumineux ambre	4301649
17	Conjunto conexión en cruz	Cross connector set	Ensemble raccord en croix	2309742
18	Conexión en cruz (4)	Cross conector (4)	Raccord en croix (4)	4309192
19	Presostato	Pressurestat	Pressostat	2302815
20	Conjunto campana presostato	Pressurestat bowl set	Ensemble cloche pressostat	2309693
21	Conjunto varilla microrruptor	Microswitch rod set	Ensemble jauge de microrrupteur	2309682
22	Conjunto microrruptor	Microswitch set	Ensemble microrrupteur	4309250
23	Conjunto resistencia cuba 1,5 kW.	Tank element set 1,5 kW.	Ensemble résistance cuve 1,5 kW.	2309746
24	Puerta completa	Door set	Porte complète	2309722
25	Conjunto cerradura de puerta	Door lock set	Ensemble serrure de porte	2309122
26	Tirador puerta	Door handle	Ouverture porte	2302857
27	Juego completo bisagras puerta	Door hinge-joint set	Ensemble charnière de porte	2309212
28	Conjunto soporte guía cesta	Basket guide support set	Ensemble supporte guide panier	2310150
29	Rebosadero	Drain plug	Bloqueur d'eau	2310130
30	Filtro	Filter	Filtre	2307524
31	Conjunto filtro desagüe	Drain plug socket filter	Ensemble filtre d'écoulement	2310112
32	Filtro de aspiración	Intake filter	Filtre d'aspiration	2307502
33	Conjunto colector	Filters halder	Ensemble bouche d'écoulement	2310128
34	Bidón abrillantador	Rinse aid container	Bidon de polissoir	2302560
35	Filtro dosificador	Doser filter	Filtre de doseur	2302842
36	Calderín de aclarado s/resistencia	Rinsing boiler without element	Chaudière rinçage sans résistance	2309677
37	Termostato seguridad calderín	Boiler safety thermostat	Thermostat sécurité chaudière	2302852
38	Conjunto resistencia calderín 2,5 kW.	Boiler element set 2,5 kW.	Ensemble résistance chaudière 2,5 kW.	2309696
39	Junta goma resistencia calderín (2)	Rubber seal boiler element (2)	Joint caoutchouc résist. chaudière (2)	2309051
40	Conjunto bomba de vaciado	Drain pump	Ensemble pompe de vidange	4309102
41	Conjunto codo aspiración vaciado	Drain pump elbow	Ensemble coude aspiration vidange	2310108
42	Conjunto codo desagüe	Drain elbows set	Ensemble coudes d'écoulement	2310106
43	Conjunto codo antirretorno	Elbow with non return valve	Ensemble coude antiretour	2307503
44	Tubo manguera desagüe	Drain hose tube	Tuyau d'écoulement	2305113
45	Conjunto electroválvula 2 vías	Electrovalve 2 v. set	Ensemble electrovalve 2 v.	2309744
46	Conjunto manguera entrada agua	Water entry tube set	Ensemble tuyau arrivée d'eau	2309745
47	Juego completo patas de goma (4)	Rubber feet set (4)	Ensemble pieds en caoutchouc (4)	2309017
48	Conjunto termostato	Thermostat set	Ensemble thermostat	2309068
49	Maneta de termostato (2)	Thermostat knob (2)	Commande de thermostat (2)	2309065
50	Conjunto dosificador de detergente	Detergent dosing set	Ensemble dosseur detergent	2309082
51	Racord codo	Elbow coupling	Raccord coude	4305756
52	Conjunto dosificador	Dosing set	Ensemble doseur	2305055
53	Juego válvulas dosificador (4)	Doser valves set (4)	Ensemble valves doseur (4)	2309085
54	Juego membrana-válvulas dosificador	Dosing membrane-valves set	Ensemble membrane-valves doseur	2309086
55	Conjunto motobomba 0,33 HP.	Motorpump set 0,33 HP.	Ensemble motopompe 0,33 HP.	2309686
56	Conjunto carcasa motobomba	Motorpump body set	Ensemble corps motopompe	2309847
57	Condensador 10MF/400 V.faston	Condenser 10MF/400 V.	Condensateur 10MF/400 V.	2305322
58	Conjunto codo de expulsión	Ejection elbow set	Ensemble coude d'expulsion	2310129
59	Conjunto codo de aspiración	Intake elbow set	Ensemble coude d'aspiration	2309655
60	Conjunto accesorios motobomba	Motorpump accessories set	Ensemble accessoires motopompe	2309747

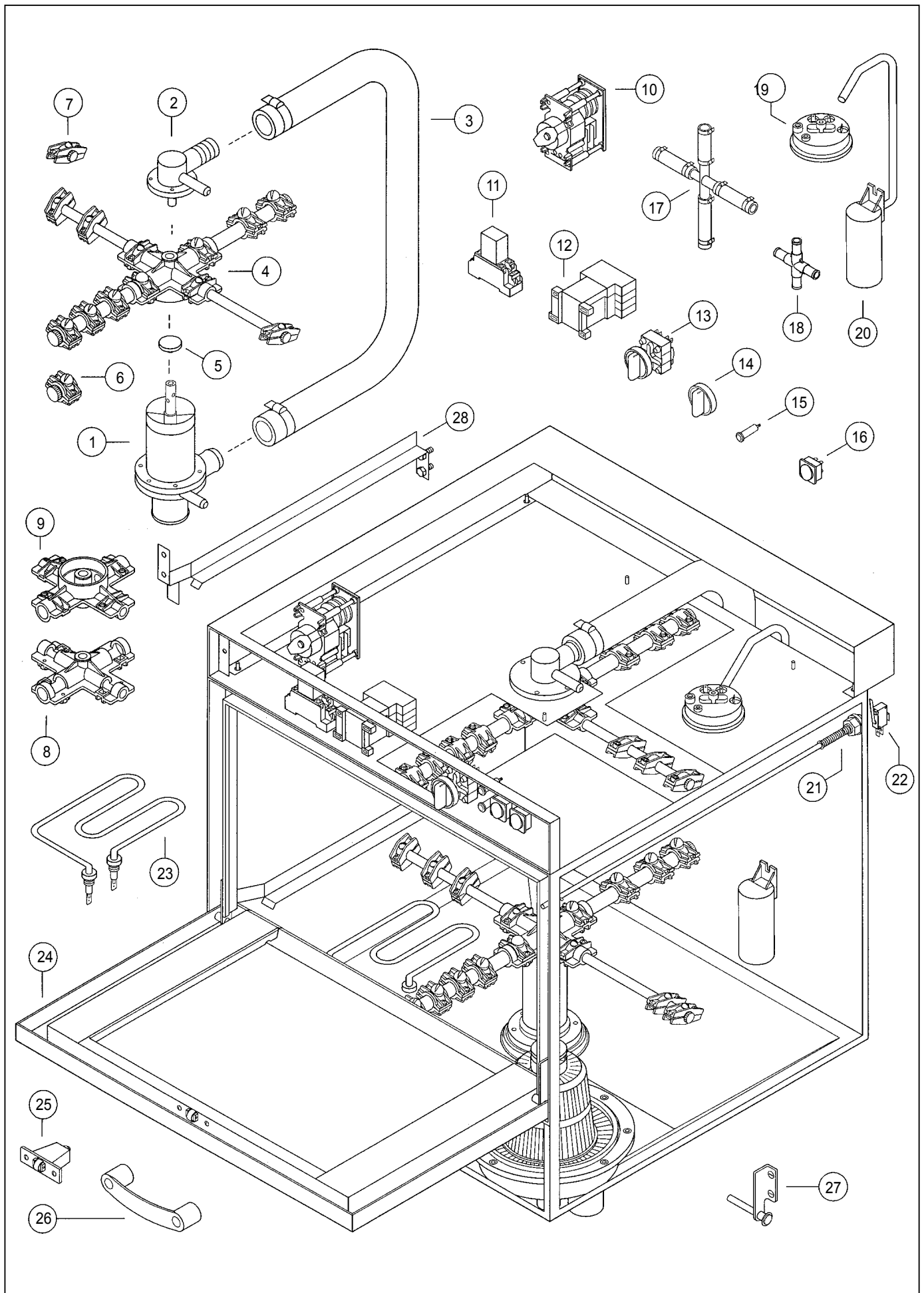

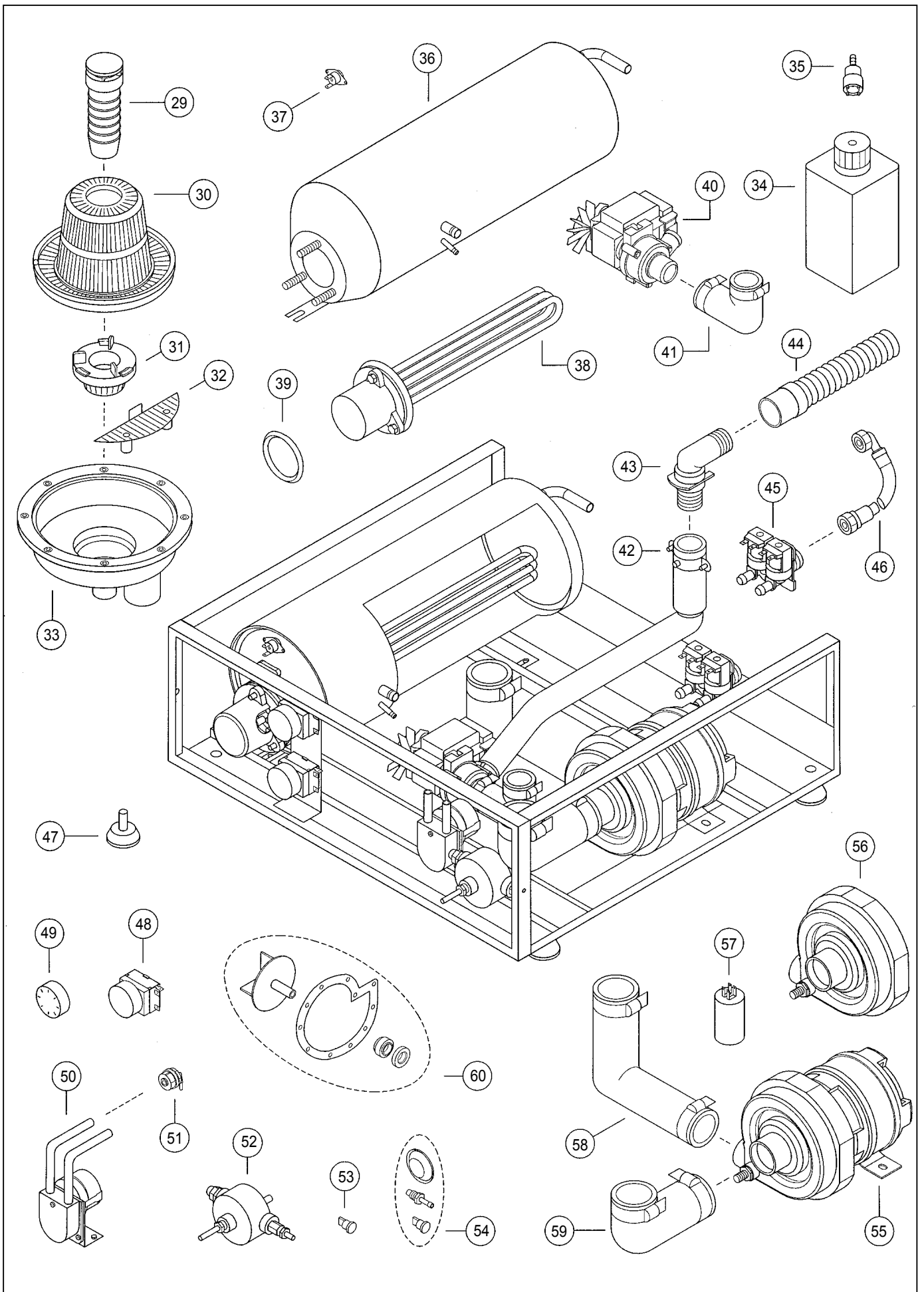



Nota: Todas estas especificaciones están sujetas a cambio sin previo aviso, debido a la permanente mejora del producto.
Note: These specifications are subject to change without notice due to continuous improvement.
Note: SAMMIC se réserve le droit de modifier et d'améliorer ses fabrications sans préavis.